

仅供参考

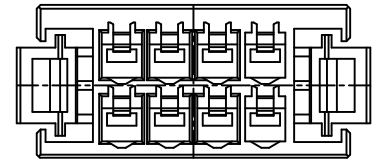

REV.	REVISION RECORD	DATE
A0	新图面发行	2017.06.16

Specifications:
 Voltage Rating : 250V AC/DC
 Current Rating : 8A AC,DC
 Withstand Voltage : 1500V AC/minute
 Contact Resistance : 40mΩ(MAX.)
 Insulation Resistance : 1000MΩ(MIN.)
 Temperature Range : -55°C~+105°C

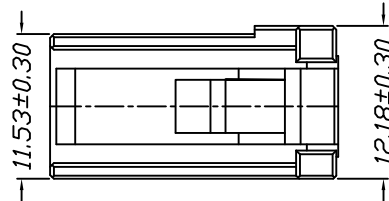
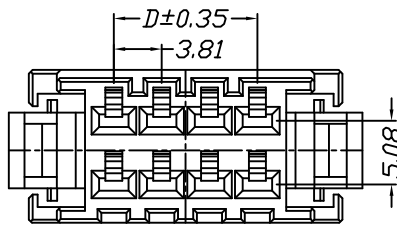
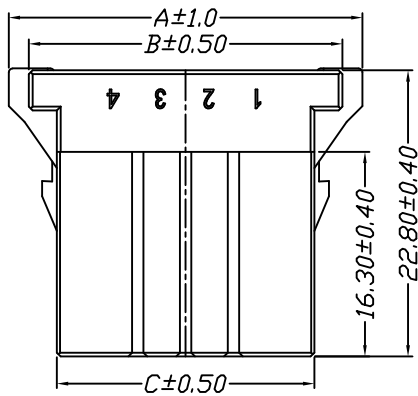
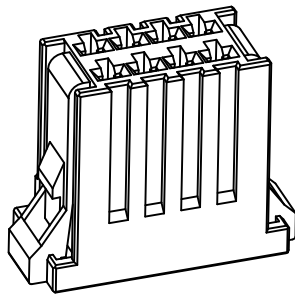

Poles	Dimensions			
	A	B	C	D
2*3P	24.36	21.16	16.70	7.62
2*4P	28.17	24.97	20.51	11.43
2*5P	31.98	28.78	24.32	15.24
2*6P	35.79	32.59	28.13	19.05
2*8P	43.41	40.21	35.75	26.67
2*10P	51.03	47.83	43.37	34.29

Material	Color
PBT UL94V-0	BLACK

	GENERAL TOLERANCES		SCALE: 1:1	NAME	DATE	 深圳市思拓展电子有限公司 SHENZHEN SINOTOP ELECTRONICS CO., LTD 公司网址: www.szstuo.cn 公司电话: 0755-23765350 电子邮箱: 2850175982@qq.com 公司传真: 0755-23765341	PART. NO: STP43811H00-2XNPA-PT
	LINEAR	ANGLES					
UNIT: MM	0.00±0.25	X° ±3°	DESIGNER			TITLE:	DWG. NO:
SIZE: A4	0.000±0.15	X° X' ±2°	DRAWN	肖坤权	2017.06.16	3.81mm PITCH Housing	REV: A0 SHEET: 1/1