

仅供参考

REV.	REVISION RECORD	DATE
A0	新图面发行	2017.06.16

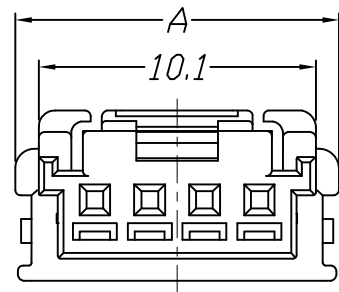
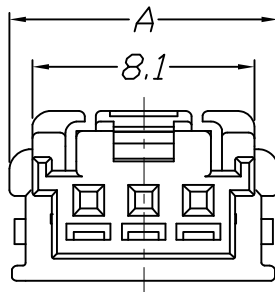
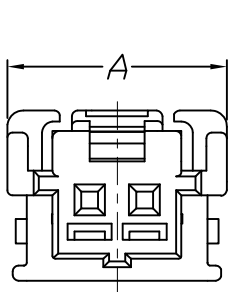
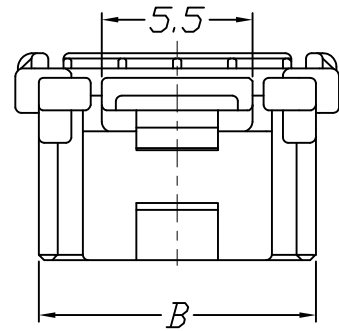
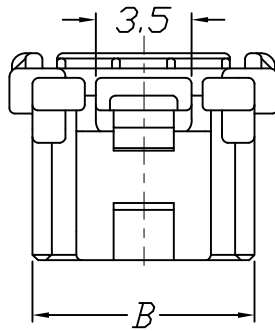
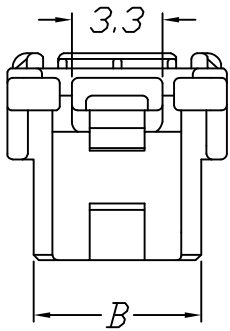
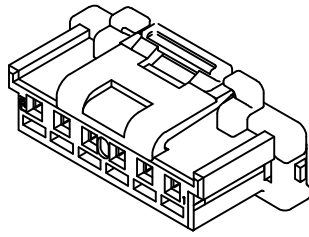

2P

3P

4P

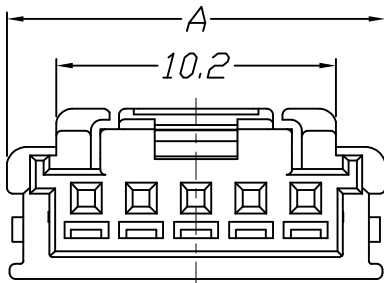
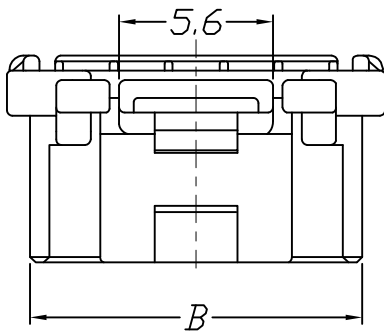

5-15P

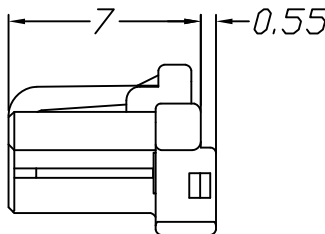

Specifications:

Voltage Rating : 125V AC/DC

Current Rating : 2A AC,DC

Withstand Voltage : 600V AC/minute

Contact Resistance : 40mΩ(MAX.)

Insulation Resistance : 1000MΩ(MIN.)

Temperature Range : -40°C~+105°C

Poles	Dimensions			
	A	B	C	D
2P	8.00	6.10	8.00	10.90
3P	9.80	8.10	10.00	12.60
4P	11.80	10.10	12.00	14.60
5P	13.80	12.10	14.00	16.60
6P	15.80	14.10	16.00	18.60
7P	17.80	16.10	18.00	20.60
8P	19.80	18.10	20.00	22.60
9P	21.80	20.10	22.00	22.00
10P	23.80	22.10	24.00	24.00
11P	25.80	24.10	26.00	26.00
12P	27.80	26.10	28.00	28.00
13P	29.80	28.10	30.00	30.00
14P	31.80	30.10	32.00	32.00
15P	33.80	32.10	34.00	34.00

Material	Color
PBT UL94V-0	BLACK

	GENERAL TOLERANCES		SCALE: 1:1	NAME	DATE	深圳市思拓展电子有限公司 SHENZHEN SINOTOP ELECTRONICS CO., LTD 公司网址: www.szstuo.cn 公司电话: 0755-23765350 邮箱: 2850175982@qq.com 公司传真: 0755-23765341	PART. NO: STP42012H01-NPX-PT
	LINEAR	ANGLES					
	0.0±0.35	X° REF±6°	DESIGNER		DWG. NO:		
UNIT: MM	0.00±0.25	X° ±3°	DESIGNER			TITLE:	
SIZE: A4	0.000±0.15	X° X'±2°	DRAWN	肖坤权	2017.06.16	2.00mm PITCH Housing	REV: A0 SHEET: 1/1